

BIOKİM

TEKNİK SİSTEMLER

“

Amacınız kalite
ise biz destekçiniziz!



- ÇEKER OCAK (FUME HOOD) -

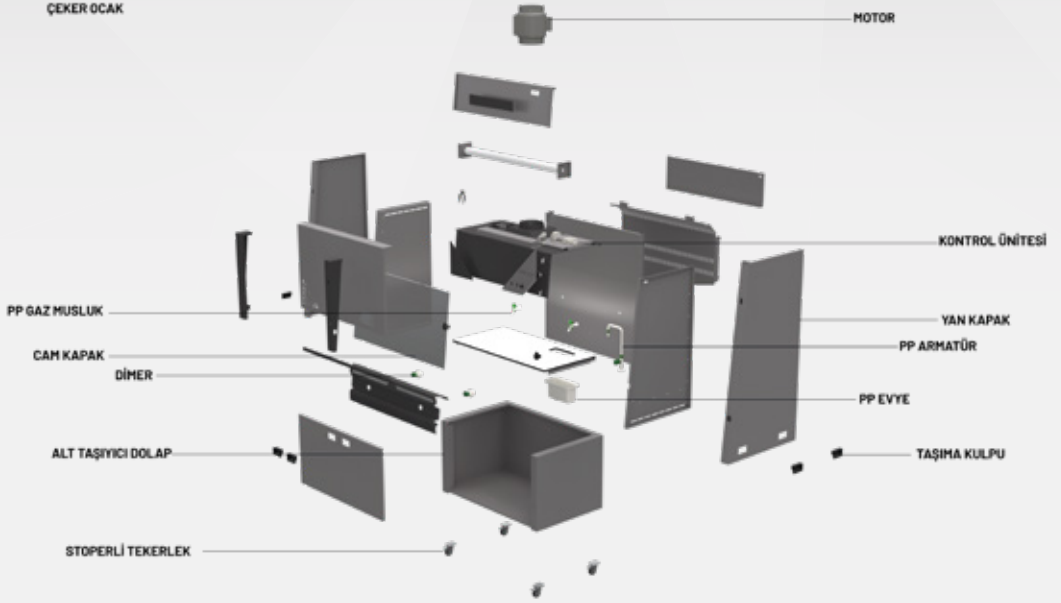

ÇEKER OCAK ÖZELLİKLERİ

- Dikey sürügülü damperli cam
- Kompakta laminan tezgah yüzeyi
- Salyangoz tipi fan
- Led aydınlatma
- Uv lamba
- Elektrostatik toz boyalı galvenize sac
- Metal alt dolap
- Pp evye ve armatürler



- LAMİNAR FLOW -

LAMİNAR FLOW CLASS II AB

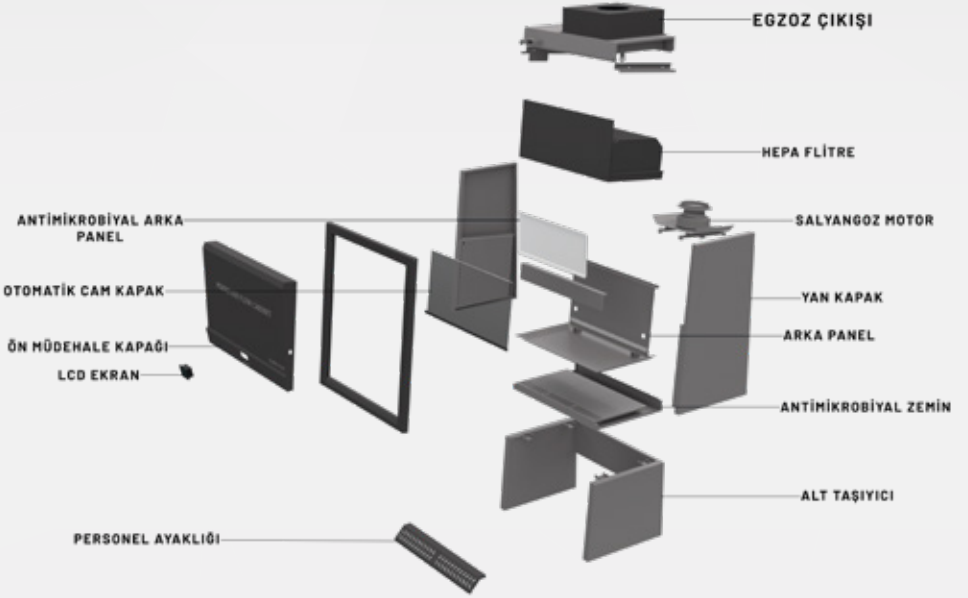

LAMİNAR FLOW ÖZELLİKLERİ

- İç kısım paslanmaz çelik
- Hepa filtreli
- Led florasan lamba
- Elektrostatik toz boyalı galvenize sac
- Salyangoz tipi fan
- Uv lamba



- C-FRAME (KONSTRÜKSİYON) KENAR TEZGAH -

KENAR TEZGAH ÖZELLİKLERİ

- Elektrostatik toz boyalı metal c ayak taşıyıcı sistem
- Modüler üretim
- Mdf lam ve metal dolap malzeme
- Pp evye ve armatür
- Tasarımda farklı renk seçenekleri
- Kompakt laminant, nanoseramik, epoksi resin çalışma yüzeyi

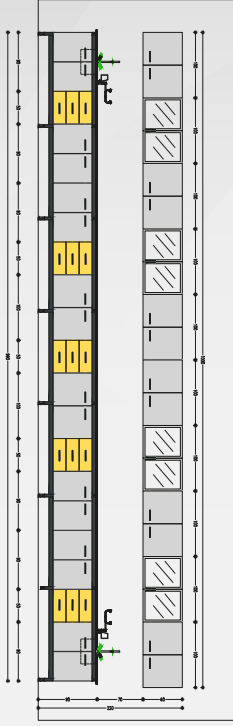

ÖN GÖRÜNÜŞ

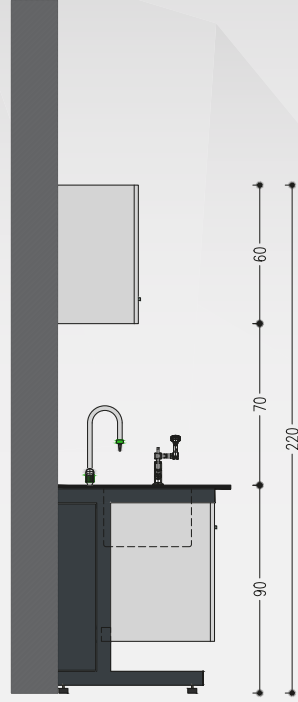

YAN GÖRÜNÜŞ

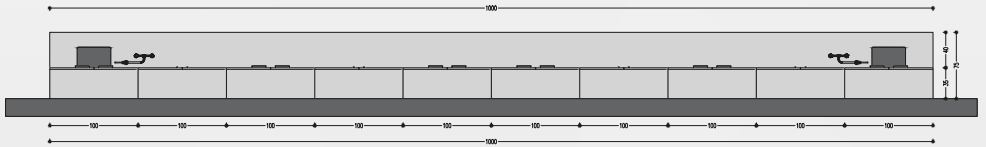

PLAN



- C-FRAME (KONSTRÜKSİYON) ORTA TEZGAH -

ORTA TEZGAH ÖZELLİKLERİ

- Metal c ayak taşıyıcı sistem
- Elektrostatik toz boyalı metal konstrüksiyon
- Modüler üretim
- Mdf lam dolap malzeme
- Pp evye ve armatür
- Tasarımda farklı renk seçenekleri
- Kompakt laminant çalışma yüzeyi
- Kompakt laminant, nanoseramik, epoksi resin çalışma yüzeyi
- Kullanıcı için data, ups ve 220v girişlere sahip enerji ünitesi

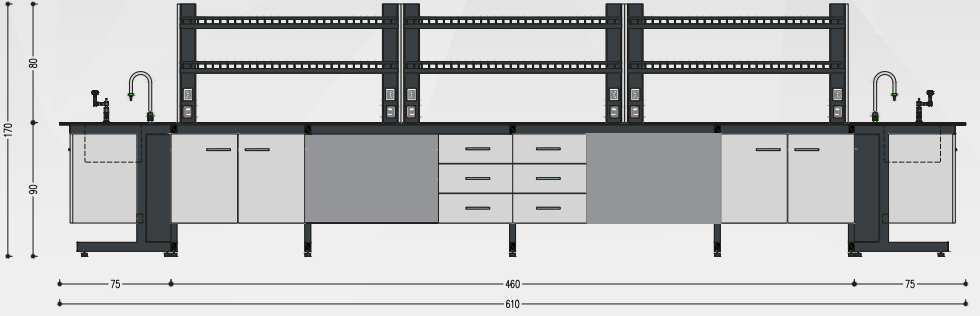

YAN GÖRÜNÜŞ

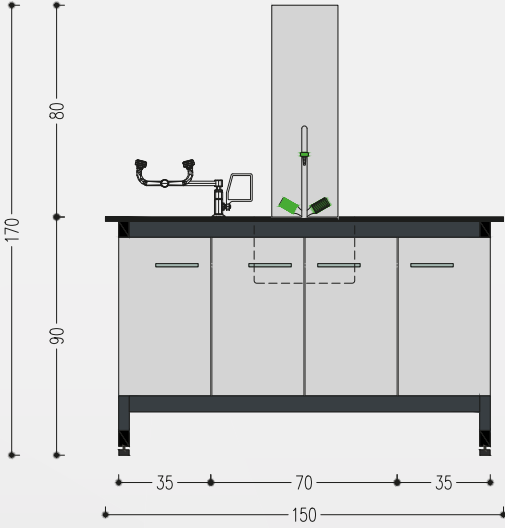

ÖN GÖRÜNÜŞ

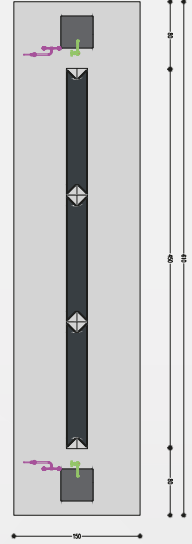

ÜST GÖRÜNÜŞ

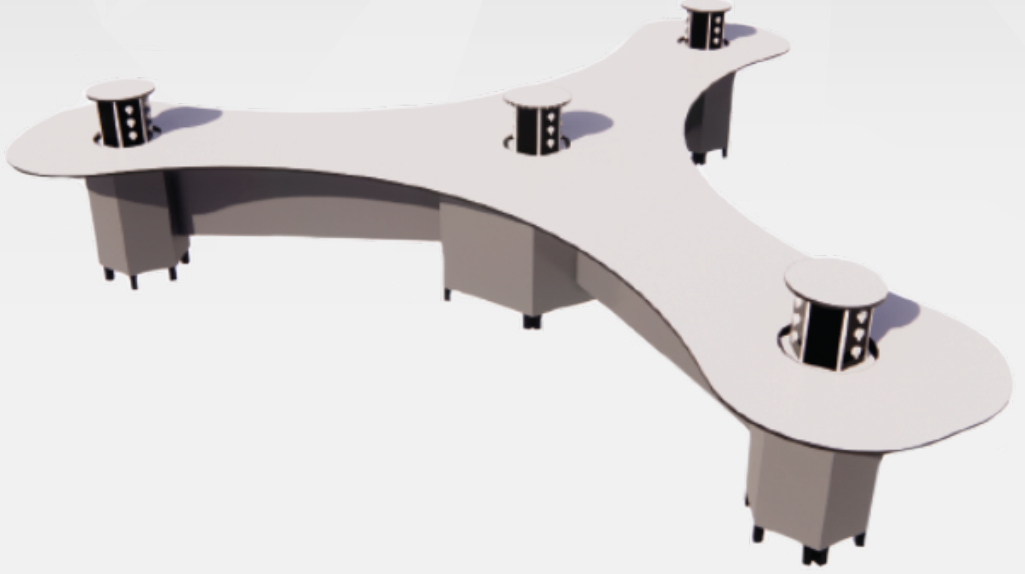

- TRIVIA -

TRIVIA ÖZELLİKLERİ

- Elektrostatik toz boyalı metal konstrüksiyon
- Modüler üretim
- Pp evye ve armatür
- Farklı disiplinler için kullanım kolaylığı
- Tasarımda farklı renk seçenekleri

- Kompakt laminant çalışma yüzeyi
- Laboratuvar standartlarına uygun tasarım
- Kullanıcı için data, ups ve 220v girişlere sahip altıgen enerji ünitesi
- Mekan içerisinde kullanıcı için alan kullanımını artırması

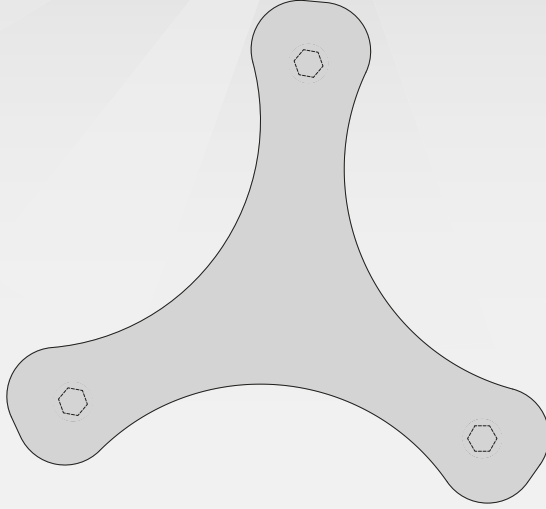

ÜST GÖRÜNÜŞ

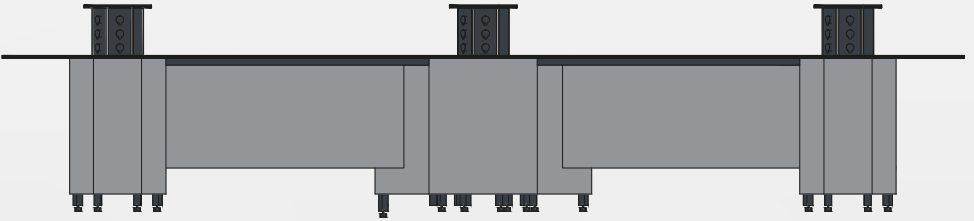

ÖN GÖRÜNÜŞ

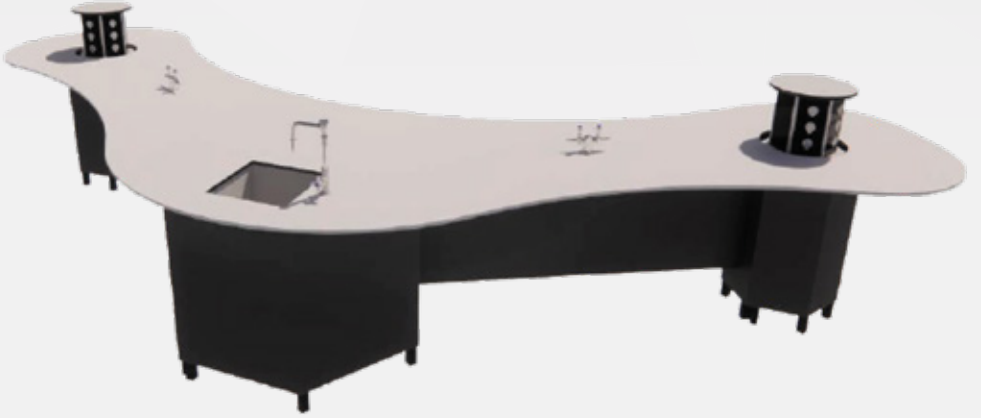

- DİMİVİA -

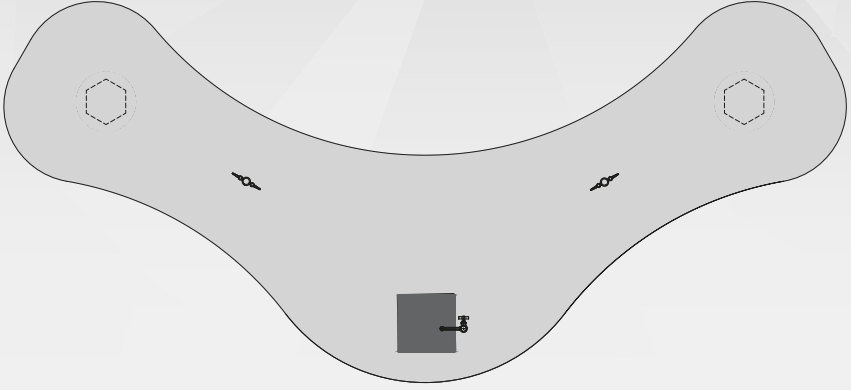

ÜST GÖRÜNÜŞ

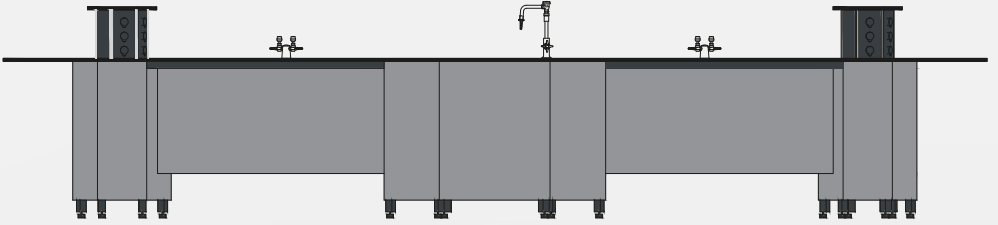

ÖN GÖRÜNÜŞ



- PP EVYE -



- ARMATÜR -

PP EVYE VE ARMATÜR ÖZELLİKLERİ

- Propipilen malzeme
- Sağlam, dayanıklı ve hafif üretim
- Kimysallar karşı dayanıklı
- Kullanım kolaylığı sağlayan tasarım



- GÖZ DUŞ -



- BOY DUŞ -



- KURUTMA ASKILIĞI -

ÜRÜNLERİN ÖZELLİKLERİ

- Propropilen malzeme
- Sağlam, dayanıklı ve hafif üretim
- Kimyasallar karşı dayanıklı
- Kullanım kolaylığı sağlayan tasarım



Biokim Teknik Sistemler Ltd.Şti
Mira Tower Tatlı Su Mah. Şenol Güneş Bulvarı
Şerifali Bölgesi No:2 K:7/38
Ümraniye /İSTANBUL



0216 455 8464



info@**biokim**.com.tr



Selçuklu Mahallesi Pınar Sok. No:3
Dadaşkent Aziziye / ERZURUM



(0442) 234 10 80 - 82



(0442) 234 10 81



info@**biokim**.com.tr